

Description

The DigiFlex® Performance™ (DP) Series digital servo drives are designed to drive brushed and brushless servomotors. These fully digital drives operate in torque, velocity, or position mode and employ Space Vector Modulation (SVM), which results in higher bus voltage utilization and reduced heat dissipation compared to traditional PWM. The command source can be generated internally or can be supplied externally. In addition to motor control, these drives feature dedicated and programmable digital and analog inputs and outputs to enhance interfacing with external controllers and devices.

This DP Series drive features a SynqNet™ interface for networking and a RS-232 interface for drive configuration and setup. Drive commissioning is accomplished using DriveWare, available at www.a-m-c.com.

All drive and motor parameters are stored in non-volatile memory.

Power Range

Peak Current	15 A (10.6 A _{RMS})
Continuous Current	7.5 A (5.3 A _{RMS})
Supply Voltage	40 - 190 VDC



Features

- ▲ Four Quadrant Regenerative Operation
- ▲ Space Vector Modulation (SVM) Technology
- ▲ Fully Digital State-of-the-art Design
- ▲ Programmable Gain Settings
- ▲ Compact Size, High Power Density
- ▲ 16-bit Analog to Digital Hardware

MODES OF OPERATION

- Current

COMMAND SOURCE

- Over the Network

FEEDBACK SUPPORTED

- Halls
- Incremental Encoder

INPUTS/OUTPUTS

- 3 Dedicated Digital Inputs
- 2 Dedicated Digital Outputs
- 2 High Speed Captures
- 2 Programmable Analog Inputs (16-bit/12-bit Resolution)
- 2 Programmable Digital Inputs (Differential)
- 2 Programmable Digital Inputs (Single-Ended)
- 2 Programmable Digital Outputs (Differential)
- 2 Programmable Digital Outputs (Single-Ended)

COMPLIANCES & AGENCY APPROVALS

- UL
- cUL
- CE Class A (LVD)
- CE Class A (EMC)
- RoHS

BLOCK DIAGRAM

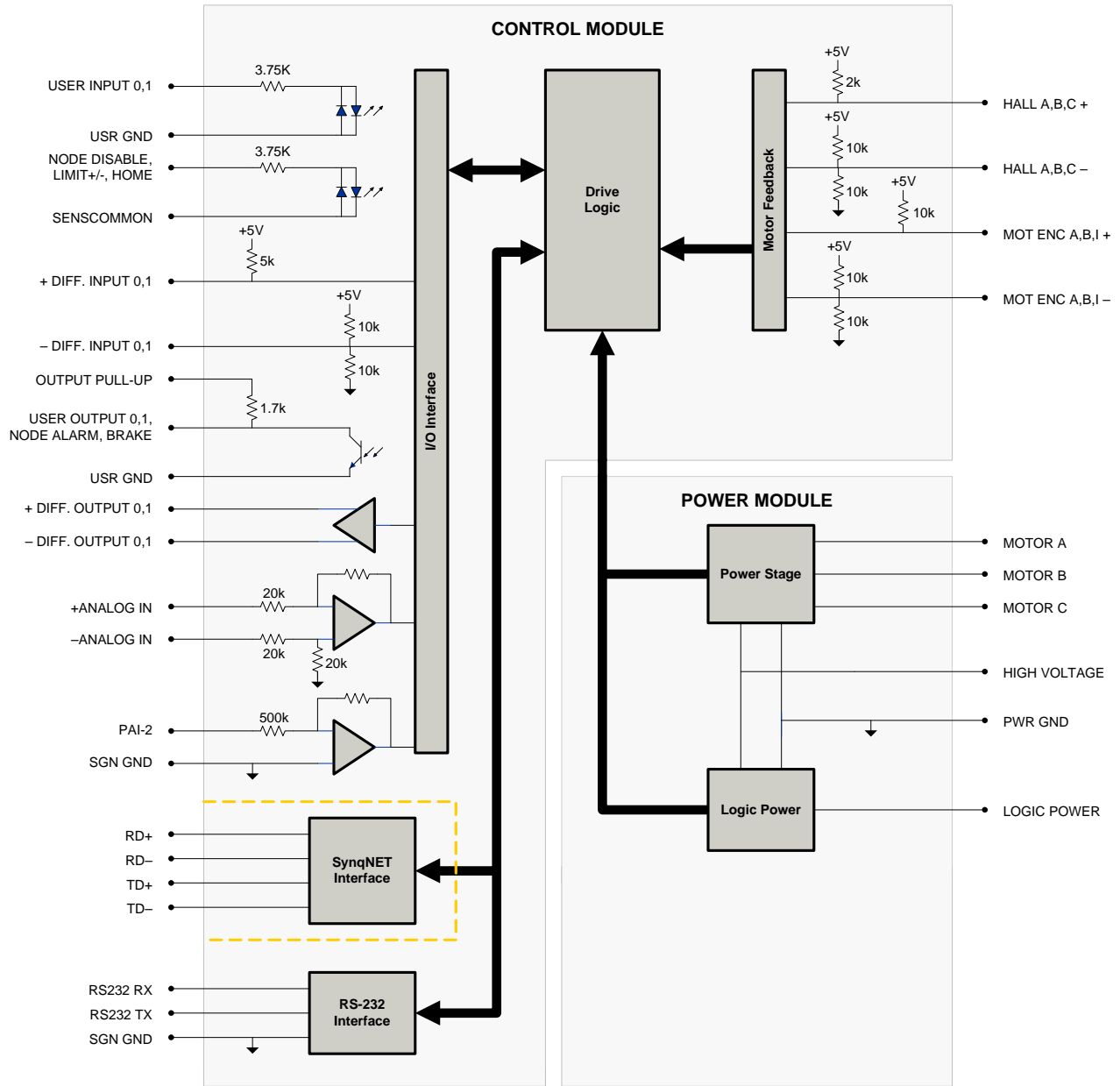

Information on Approvals and Compliances



US and Canadian safety compliance with UL 508c, the industrial standard for power conversion electronics. UL registered under file number E140173. Note that machine components compliant with UL are considered UL registered as opposed to UL listed as would be the case for commercial products.



Compliant with European CE for both the Class A EMC Directive 2004/108/EC on Electromagnetic Compatibility (specifically EN 61000-6-4:2007 and EN 61000-6-2:2005) and LVD requirements of directive 2006/95/EC (specifically EN 60204-1:2006), a low voltage directive to protect users from electrical shock.



RoHS (Reduction of Hazardous Substances) is intended to prevent hazardous substances such as lead from being manufactured in electrical and electronic equipment.

SPECIFICATIONS

Power Specifications		
Description	Units	Value
DC Supply Voltage Range	VDC	40 - 190
DC Bus Over Voltage Limit	VDC	198
DC Bus Under Voltage Limit	VDC	35
Logic Supply Voltage	VDC	40 - 190
Maximum Peak Output Current ¹	A (Arms)	15 (10.6)
Maximum Continuous Output Current	A (Arms)	7.5 (5.3)
Maximum Continuous Output Power	W	1353.8
Maximum Power Dissipation at Continuous Current	W	71.3
Internal Bus Capacitance	µF	20
Minimum Load Inductance (Line-To-Line) ²	µH	250
Switching Frequency	kHz	16
Maximum Output PWM Duty Cycle	%	100
Low Voltage Supply Outputs	-	+5 VDC (250 mA)
Control Specifications		
Description	Units	Value
Communication Interfaces	-	SynqNet (RS-232 for configuration)
Command Sources	-	Over the Network
Feedback Supported	-	Halls, Incremental Encoder
Commutation Methods	-	Sinusoidal, Trapezoidal
Modes of Operation	-	Current
Motors Supported	-	Closed Loop Vector, Single Phase (Brushed, Voice Coil, Inductive Load), Three Phase (Brushless)
Hardware Protection	-	40+ Configurable Functions, Over Current, Over Temperature (Drive & Motor), Over Voltage, Short Circuit (Phase-Phase & Phase-Ground), Under Voltage
Programmable Digital Inputs/Outputs (PDIs/PDOs)	-	4/2
Programmable Analog Inputs/Outputs (PAIs/PAOs)	-	2/0
Current Loop Sample Time	µs	62.5
Maximum Encoder Frequency	MHz	5 (1.25 pre-quadrature)
Mechanical Specifications		
Description	Units	Value
Agency Approvals	-	CE Class A (EMC), CE Class A (LVD), cUL, RoHS, UL
Size (H x W x D)	mm (in)	132.5 x 89.5 x 35.9 (5.2 x 3.5 x 1.4)
Weight	g (oz)	500 (17.6)
Heatsink (Base) Temperature Range ³	°C (°F)	0 - 65 (32 - 149)
Storage Temperature Range	°C (°F)	-40 - 85 (-40 - 185)
Form Factor	-	Panel Mount
Cooling System	-	Natural Convection
IP Rating	-	IP10
AUX COMM Connector	-	3-pin, 2.5 mm spaced, enclosed, friction lock header
COMM IN Connector	-	Shielded RJ-45 socket with LEDs
COMM OUT Connector	-	Shielded RJ-45 socket with LEDs
FEEDBACK Connector	-	15-pin, high-density, female D-sub
I/O Connector	-	26-pin, high-density, female D-sub
POWER Connector	-	6-pin, 3.96 mm spaced, friction lock header

Notes

1. Capable of supplying drive rated peak current for 2 seconds with 10 second foldback to continuous value. Longer times are possible with lower current limits.
2. Lower inductance is acceptable for bus voltages well below maximum. Use external inductance to meet requirements.
3. Additional cooling and/or heatsink may be required to achieve rated performance.

PIN FUNCTIONS

AUX COMM - RS232 Communication Connector			
Pin	Name	Description / Notes	I/O
1	RS232 RX	Receive Line (RS-232)	I
2	RS232 TX	Transmit Line (RS-232)	O
3	SGN GND	Signal Ground	SGND

COMM IN - SynqNet Communication Connector			
Pin	Name	Description / Notes	I/O
1	RD+	Receiver Line (100BaseT)	I
2	RD-		I
3	TD+	Transmitter Line (100BaseT)	O
4	RESERVED	Reserved	-
5	RESERVED	Reserved	-
6	TD-	Transmitter Line (100BaseT)	O
7	RESERVED	Reserved	-
8	RESERVED	Reserved	-

COMM OUT - SynqNet Communication Connector			
Pin	Name	Description / Notes	I/O
1	TD+	Transmitter Line (100BaseT)	O
2	TD-		O
3	RD+	Receiver Line (100BaseT)	I
4	RESERVED	Reserved	-
5	RESERVED	Reserved	-
6	RD-	Receiver Line (100BaseT)	I
7	RESERVED	Reserved	-
8	RESERVED	Reserved	-

FEEDBACK - Feedback Connector			
Pin	Name	Description / Notes	I/O
1	HALL A+	Commutation Sensor Inputs	I
2	HALL B+		I
3	HALL C+		I
4	MOT ENC A+	Differential Encoder A Channel Input (For Single Ended Signals Use Only The Positive Input)	I
5	MOT ENC A-		I
6	MOT ENC B+	Differential Encoder B Channel Input (For Single Ended Signals Use Only The Positive Input)	I
7	MOT ENC B-		I
8	MOT ENC I+	Differential Encoder Index Input (For Single Ended Signals Use Only The Positive Input)	I
9	MOT ENC I-		I
10	HALL A-	Commutation Sensor Input (For Differential Signals Only)	I
11	HALL B-	Commutation Sensor Input (For Differential Signals Only)	I
12	SGN GND	Signal Ground	SGND
13	+5V OUT	+5V Encoder Supply Output (Short Circuit Protected)	O
14	PAI-2	Programmable Analog Input (12-bit Resolution)	I
15	HALL C-	Commutation Sensor Input (For Differential Signals Only)	I

I/O - Signal Connector

Pin	Name	Description / Notes	I/O
1	USER OUTPUT 0 (PDO-1)	24V Isolated Programmable Digital Output (Referenced To USER GND)	O
2	USER OUTPUT 1 (PDO-2)	24V Isolated Programmable Digital Output (Referenced To USER GND)	O
3	USER GND	Ground Reference For User Outputs And Inputs	ISO GND
4	NODE ALARM (PDO-12)	24V Network Error (Isolated Output Referenced To USER GND)	O
5	BRAKE (PDO-13)	24V Brake (Isolated Output Referenced to USER GND)	O
6	SGN GND	Signal Ground	SGND
7	+ DIFF. INPUT 0 (PDI-3)	5V Non-Isolated Differential Digital Input	I
8	- DIFF. INPUT 0 (PDI-3)		I
9	OUTPUT PULL-UP	Digital Output Pull-Up For User Outputs	I
10	NODE DISABLE (PDI-12)	24V Node Disable (Isolated Input Referenced to SENSCOMMON)	I
11	LIMIT + (PDI-9)	24V Positive Limit (Isolated Input Referenced To SENSCOMMON)	I
12	LIMIT - (PDI-10)	24V Negative Limit (Isolated Input Referenced To SENSCOMMON)	I
13	HOME (PDI-11)	24V Home Switch (Isolated Input Referenced To SENSCOMMON)	I
14	USER INPUT 0 (PDI-1)	24V Isolated Programmable Digital Input (Referenced To USER GND)	I
15	USER INPUT 1 (PDI-2)	24V Isolated Programmable Digital Input (Referenced To USER GND)	I
16	SENSCOMMON	Sensor Common (Can Be Used To Pull-Up Related Inputs)	CMN
17	+ DIFF. INPUT 1 (PDI-4)	5V Non-Isolated Differential Digital Input	I
18	- DIFF. INPUT 1 (PDI-4)		I
19	SGN GND	Signal Ground	SGND
20	+ DIFF. OUTPUT 0 (PDO-3)	5V Non-Isolated Differential Digital Output	O
21	- DIFF. OUTPUT 0 (PDO-3)		O
22	+ DIFF. OUTPUT 1 (PDO-4)	5V Non-Isolated Differential Digital Output	O
23	- DIFF. OUTPUT 1 (PDO-4)		O
24	+ ANALOG IN (PAI-1)	±10V Programmable Differential Analog Input (16-bit Resolution)	I
25	- ANALOG IN (PAI-1)		I
26	SGN GND	Signal Ground	SGND

POWER - Power Connector

Pin	Name	Description / Notes	I/O
1	MOTOR A	Motor Phase A	O
2	MOTOR B	Motor Phase B	O
3	MOTOR C	Motor Phase C	O
4	HIGH VOLTAGE	DC Power Input	I
5	PWR GND	Power Ground (Common With Signal Ground)	PGND
6	LOGIC PWR	Logic Supply Input	I

HARDWARE SETTINGS

Switch Functions

Switch	Description	Setting	
		On	Off
1	Bit 0 of binary SynqNet drive address. Does not affect RS-232 settings.	1	0
2	Bit 1 of binary SynqNet drive address. Does not affect RS-232 settings.	1	0
3	Bit 2 of binary SynqNet drive address. Does not affect RS-232 settings.	1	0
4	Bit 3 of binary SynqNet drive address. Does not affect RS-232 settings.	1	0
5	Bit 4 of binary SynqNet drive address. Does not affect RS-232 settings.	1	0
6	Bit 5 of binary SynqNet drive address. Does not affect RS-232 settings.	1	0
7	Bit 6 of binary SynqNet drive address. Does not affect RS-232 settings.	1	0
8	Bit 7 of binary SynqNet drive address. Does not affect RS-232 settings.	1	0

LED Functions

LINK_IN LED	
On	Receive Valid
Off	Not Valid or Power Off or Reset
CYCLIC LED	
On	Network Cyclic
Off	Power Off or Reset
Blinking	Network Not Cyclic
LINK_OUT LED	
On	Receive Valid
Off	Not Valid or Power Off or Reset
REPEATER LED	
On	Repeater On, Network Cyclic
Off	Repeater Off or Power Off or Reset
Blinking	Repeater On, Network Not Cyclic

MECHANICAL INFORMATION

AUX COMM - RS232 Communication Connector

Connector Information	3-pin, 2.5 mm spaced, enclosed, friction lock header	
Mating Connector	Details	Phoenix: Plug P/N 1881338
	Included with Drive	Yes

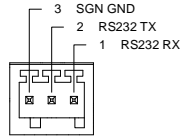

COMM IN - SynqNet Communication Connector

Connector Information	Shielded RJ-45 socket with LEDs	
Mating Connector	Details	AMP: Plug P/N 5-569552-3
	Included with Drive	No

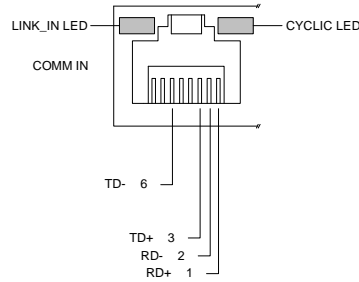

COMM OUT - SynqNet Communication Connector

Connector Information	Shielded RJ-45 socket with LEDs	
Mating Connector	Details	AMP: Plug P/N 5-569552-3
	Included with Drive	No

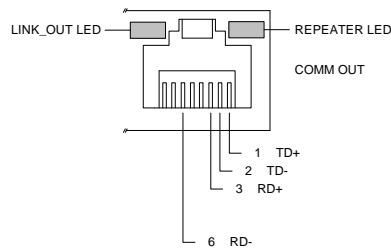

FEEDBACK - Feedback Connector

Connector Information		15-pin, high-density, female D-sub
Mating Connector	Details	TYCO: Plug P/N 748364-1; Housing P/N 5748677-1; Terminals P/N 1658670-2 (loose) or 1658670-1 (strip)
	Included with Drive	No

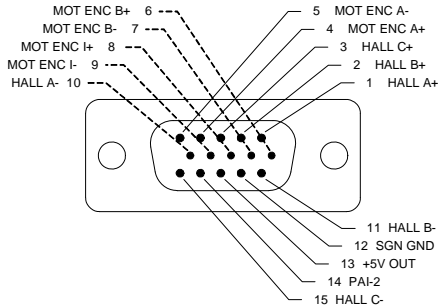

I/O - Signal Connector

Connector Information		26-pin, high-density, female D-sub
Mating Connector	Details	TYCO: Plug P/N 1658671-1; Housing P/N 5748677-2; Terminals P/N 1658670-2 (loose) or 1658670-1 (strip)
	Included with Drive	No

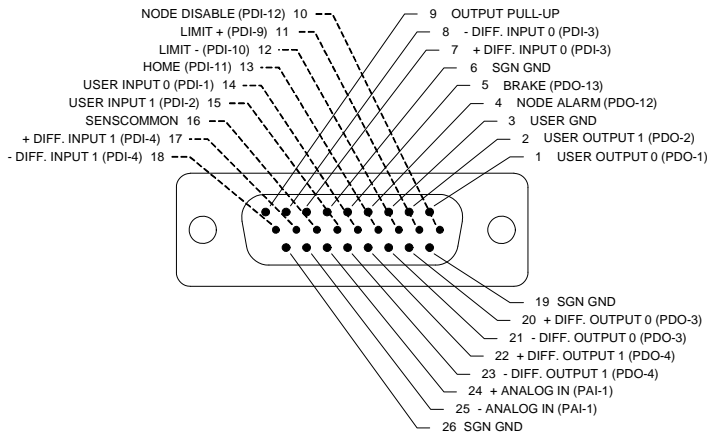

POWER - Power Connector

Connector Information		6-pin, 3.96 mm spaced, friction lock header
Mating Connector	Details	AMP: Plug P/N 770849-6; Terminals P/N 770522-1 (loose) or 770476-1 (strip)
	Included with Drive	Yes

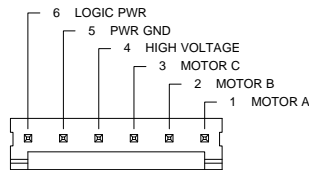

MOUNTING DIMENSIONS

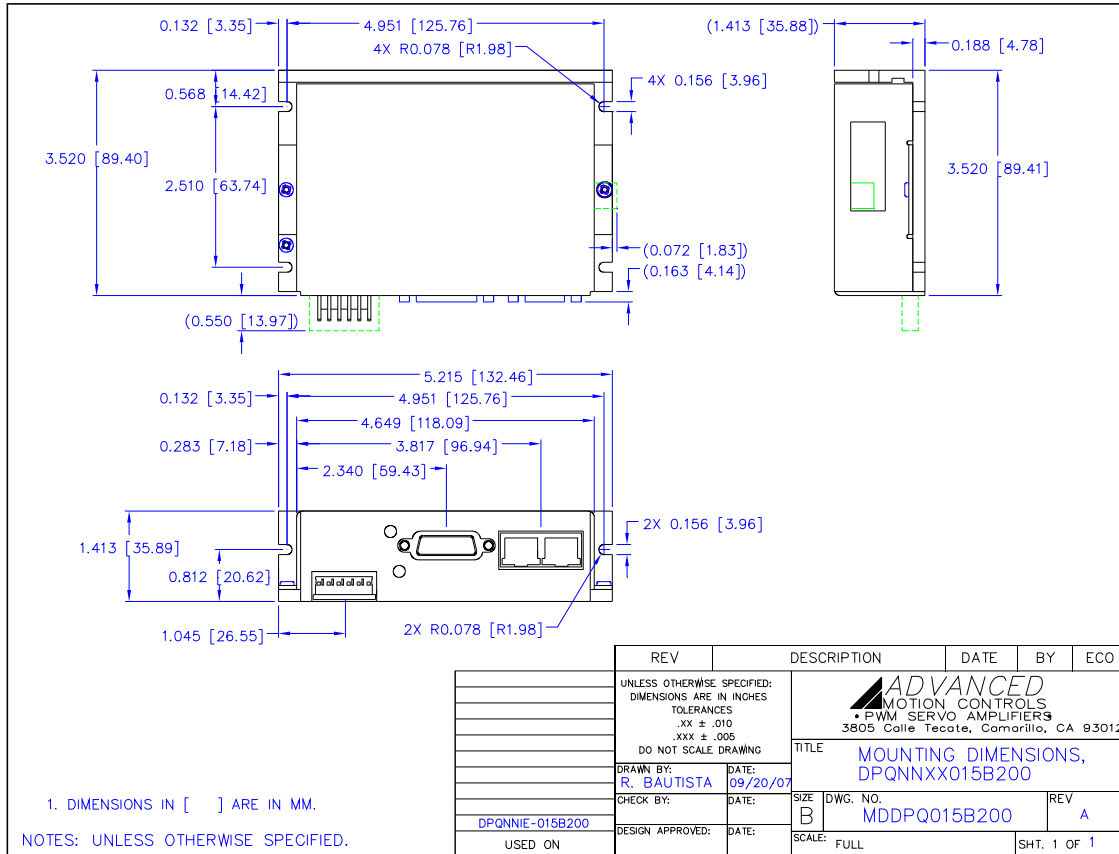

PART NUMBERING INFORMATION

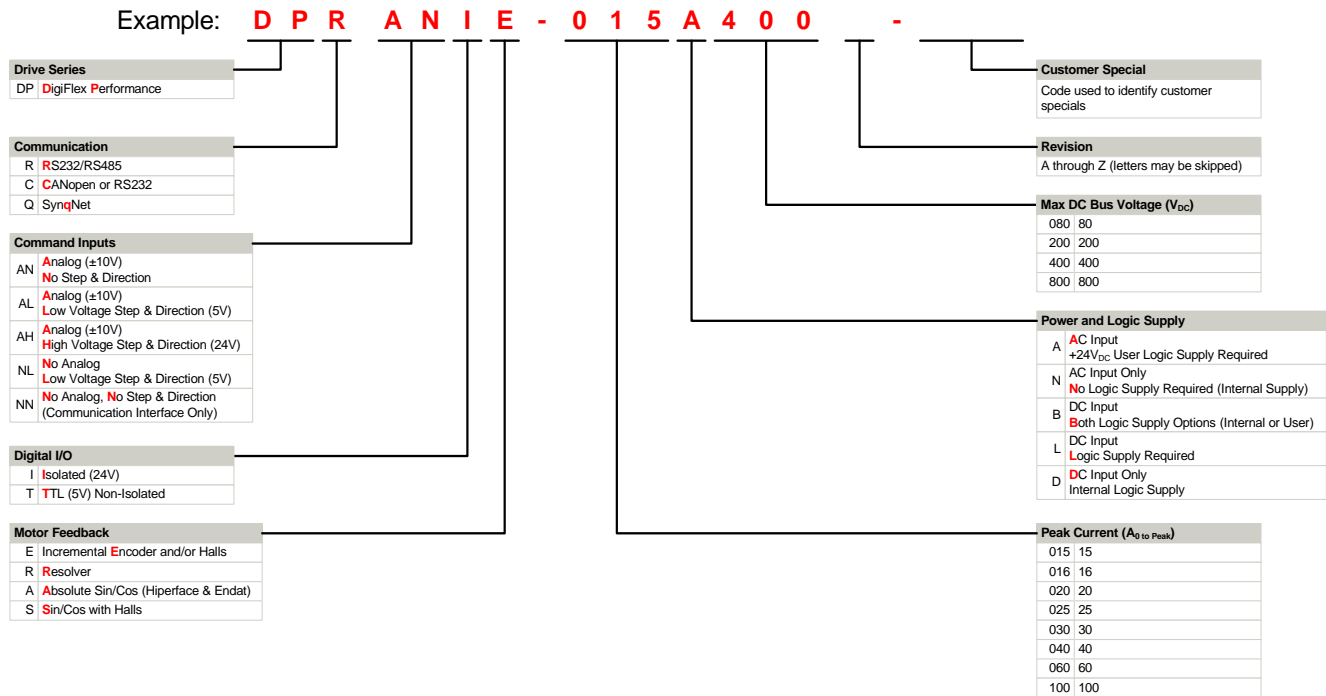

DigiFlex® Performance™ series of products are available in many configurations. Note that not all possible part number combinations are offered as standard drives. All models listed in the selection tables of the website are readily available, standard product offerings.

ADVANCED Motion Controls also has the capability to promptly develop and deliver specified products for OEMs with volume requests. Our Applications and Engineering Departments will work closely with your design team through all stages of development in order to provide the best servo drive solution for your system. Equipped with on-site manufacturing for quick-turn customs capabilities, ADVANCED Motion Controls utilizes our years of engineering and manufacturing expertise to decrease your costs and time-to-market while increasing system quality and reliability. Feel free to contact Applications Engineering for further information and details.

Examples of Customized Products

- ▲ Optimized Footprint
- ▲ Private Label Software
- ▲ OEM Specified Connectors
- ▲ No Outer Case
- ▲ Increased Current Resolution
- ▲ Increased Temperature Range
- ▲ Custom Control Interface
- ▲ Integrated System I/O
- ▲ Tailored Project File
- ▲ Silkscreen Branding
- ▲ Optimized Base Plate
- ▲ Increased Current Limits
- ▲ Increased Voltage Range
- ▲ Conformal Coating
- ▲ Multi-Axis Configurations
- ▲ Reduced Profile Size and Weight

Available Accessories

ADVANCED Motion Controls offers a variety of accessories designed to facilitate drive integration into a servo system. Visit www.a-m-c.com to see which accessories will assist with your application design and implementation.



All specifications in this document are subject to change without written notice. Actual product may differ from pictures provided in this document.